

WAVE ©

estal

www.estal.com
+34 972 821 676

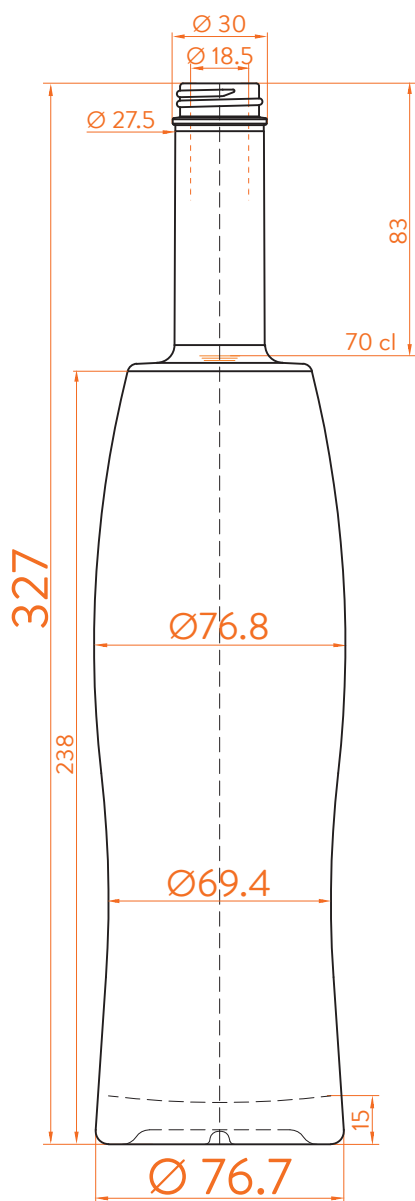

Modelo registrado/
Registered model/
Modèle enregistré



EXTRA FLINT



DATOS TÉCNICOS TECHNICAL DATA DONNÉES TECHNIQUES

Peso / Weight / Poids

750 gr

Altura total / Total height / Hauteur totale

327 mm

Diámetro del cuerpo / Body diameter / Diamètre du corps

76,7 / 76,8 mm

Ø interno boca / Ø inner mouth / Ø intérieur bouche

18,5 mm

Capacidad a verter / Brimfull / Capacité Ras-Bord

726 ml

70 cl

At first the WAVE range is proposed in 70, 75 and 150 cl.
Following business opportunities, other sizes - from miniature 5 cl to big sizes 300 cl will be added to the range.

The elements detailed in this document are not contractual. They are only indicative.