

SENSO[®]

estal

www.estal.com
+34 972 821 676

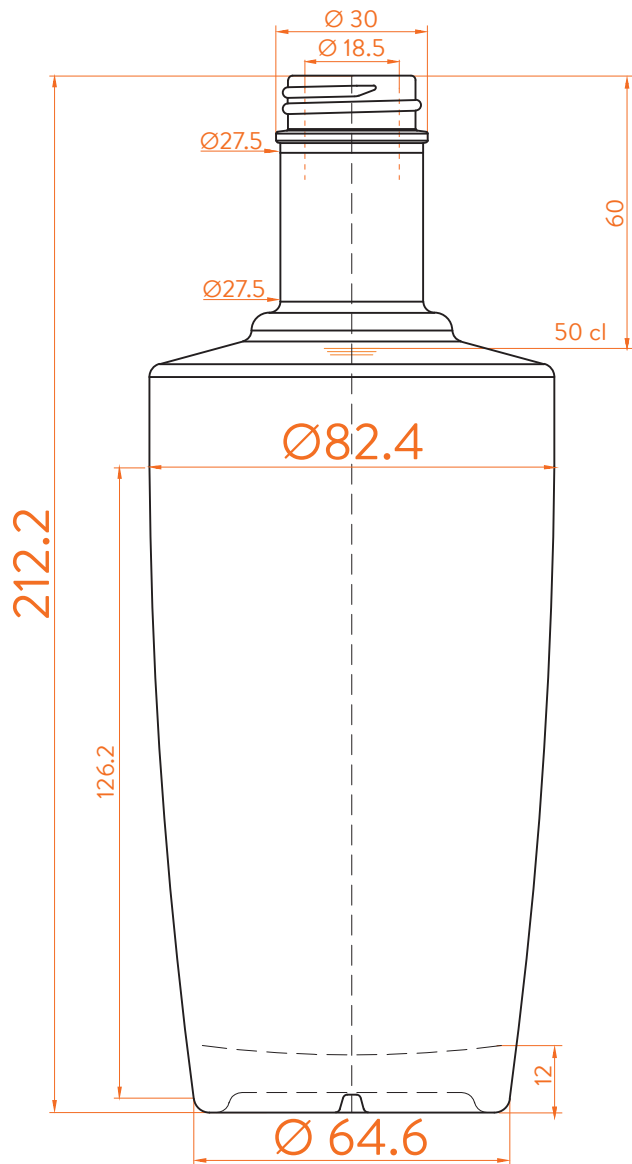

Modelo registrado/
Registered model/
Modèle enregistré



EXTRA FLINT



DATOS TÉCNICOS TECHNICAL DATA DONNÉES TECHNIQUES

Peso / Weight / Poids

580 gr

Altura total / Total height / Hauteur totale

212,2 mm

Diámetro del cuerpo / Body diameter / Diamètre du corps

64,6 / 82,4 mm

Ø interno boca / Ø inner mouth / Ø intérieur bouche

18,5 mm

Capacidad a verter / Brimfull / Capacité Ras-Bord

515 ml

50 cl

At first the SENSO range is proposed in 5, 20, 50, 70 and 75 cl.
Following business opportunities, other sizes - from miniature 5 cl to big sizes 300 cl will be added to the range.

The elements detailed in this document are not contractual. They are only indicative.